

iD Square

LUXURY VINYL TILES

Stimulate
ambiances
and gain easy
access to the
underfloor



CARPET
GREY
24563 073

ENGLISH OAK
GREY
24576 303

EDITO

In a fast-paced, ever-changing world, the workplace of today is constantly shifting and with new technologies and policies arising, employees have the freedom to choose where and how they work. Companies will continue to promote their workspaces and need to engage their employees by providing spaces for better creativity and effective collaboration. Creating vibrant offices and providing flexibility is becoming critical for attracting the best and brightest people. And the Workplace segment is not the only one adapting to major trends. The Hospitality industry is undergoing fundamental changes to best address their guests' expectations and deliver exceptional customer experience. Committed to staying on the leading edge of trends in both segments, Tarkett has designed iD Square, an acoustic loose-lay collection tailored to the specific needs of these markets.

CONTENTS

iD SQUARE APPLIED TO WORKPLACE AND HOSPITALITY TRENDS

FLEXIBLE WORKSPACE	4
COLLABORATIVE WORKSPACE	12
CARING WORKSPACE	20
HOSPITALITY	28

THE PERFECT FIT WITH DESSO CARPETS

FUSION: A BEAUTIFUL BALANCE OF ID SQUARE AND CARPET TILES	36
DOING GOOD. TOGETHER.	48
TECHNICAL BENEFITS	50
COLLECTION	52
TECHNICAL SPECIFICATIONS	58



Flexible
Workspace

CHAMBRAY
PETROL
24563 086

CHAMBRAY
GREEN
24563 083

CHAMBRAY
DARK GREY
24563 081

CHAMBRAY
OCHRE
24563 084

CITIZEN OAK
NATURAL
24593 088

CEMENT
LIGHT GREY
24563 094

FLEXIBLE WORKSPACE

By 2020, Generation Y or 'Millennials' and Generation Z will comprise more than half of the workforce. They are digital natives, collaborative, adept at multitasking and their attitudes and expectations will have a major impact on the work environment as they are striving for greater autonomy and flexibility. They expect a genuinely agile work ecosystem, with good internet access, where they can work from basically anywhere - co-working spaces, hotel lobbies, unassigned seating areas, individual work spaces or unconventional work spaces ranging from corridors to nooks or crannies. It is vital that these dynamic spaces contribute to productivity, creativity, and health of these employees. Tarkett designers have come up with several exciting and unusual colour and texture combinations that have been adapted for each concept area.



MARBLE PULPIS Grey
 □ 24565 078 66 x 66 cm



ENGLISH OAK Grey
 ■ 24576 303 25 x 100 cm



CEMENT CHEVRON Medium Grey
 ■ 24567 096 25 x 100 cm



CEMENT Light Grey
 □ 24563 094 50 x 50 cm



CEMENT Medium Grey
 □ 24563 095 50 x 50 cm
 □ 24588 095 100 x 100 cm



CEMENT Dark Grey
 □ 24563 093 50 x 50 cm

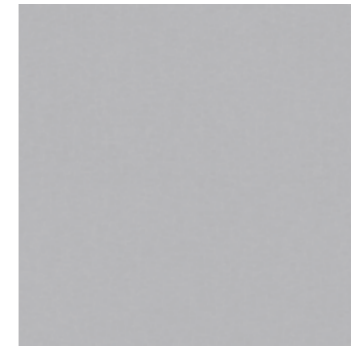

CHAMBRAY Light Grey
 □ 24563 080 50 x 50 cm
 □ 24588 080 100 x 100 cm



CARPET Grey
 □ 24563 073 50 x 50 cm

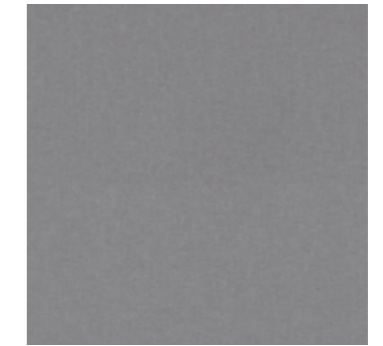

CHAMBRAY Dark Grey
 □ 24563 081 50 x 50 cm



CHAMBRAY Grey Beige
 □ 24563 082 50 x 50 cm



CHAMBRAY Petrol
 □ 24563 086 50 x 50 cm



CHAMBRAY Denim
 □ 24563 079 50 x 50 cm



CARPET Denim
 □ 24563 074 50 x 50 cm



CHAMBRAY Dark Denim
 □ 24563 085 50 x 50 cm



CEMENT CHEVRON
MEDIUM GREY 24567 096

CEMENT
DARK GREY
24563 093



CARPET
DENIM
24563 074

CHAMBRAY
DARK DENIM
24563 085

CHAMBRAY
DENIM
24563 079



CHAMBRAY
DARK GREY
24563 081

PATINE
SOLID RED
24564 068

CEMENT
LIGHT GREY
24563 094

PRIORITIES	CONSTRUCTION
CONCEPTS, QUASS	ROUGH INS
FINISHING	ROUGH INS
PRICING	BOARDING
LIGHTING, FINISHING	PAINT
	FRAMING
	ROUGH INS
	CLEAN UP
	FRAMING
	DRYWALL
	DRYWALL
	FRAMING
	DIG
	DIG
	NEW SITE PLAN

Collaborative
Workspace

MINIMAL WOOD
DARK GREY
24567 102
24563 102

PATINE
CHALK
24564 064

COLLABORATIVE WORKSPACE

Initially, shared office spaces were typically related to start-ups. This trend has majorly spread over the years to break into almost every organization seeking to stimulate open collective thinking, innovation, and fresh perspectives thus going beyond the cubicle!

From wide open-plan offices that are modular and easily adaptable, to fragmented open concepts where areas are clearly delineated, open spaces naturally allow employees to interact frequently with each other and make the workspace more agile.

Our design team has sought to inject bright and modern materials and textures into these spaces to emanate an appealing and inspired feel.



VINTAGE ZINC **Metallic**
 □ 24565 002 66 x 66 cm
 □ 24588 002 100 x 100 cm



VINTAGE ZINC **Oxyde**
 □ 24565 069 66 x 66 cm



VINTAGE ZINC **Dark Grey**
 □ 24565 000 66 x 66 cm



MINIMAL WOOD **Dark Grey**
 □ 24567 102 25 x 100 cm
 □ 24563 102 50 x 50 cm



WOVEN VINYL **Dark**
 □ 24562 090 50 x 50 cm



TISSE **Dark Grey**
 □ 24560 032 50 x 50 cm



TERRAZZO MURANO **Multico**
 □ 24563 075 50 x 50 cm

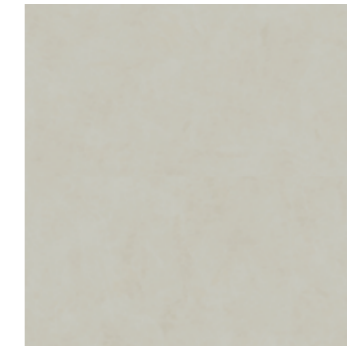

PATINE **Chalk**
 □ 24564 064 50 x 50 cm

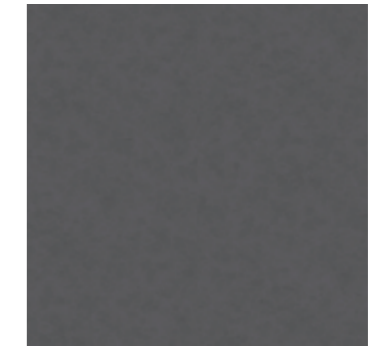

PATINE **Dark Anthracite**
 □ 24564 046 50 x 50 cm



PATINE **Solid Red**
 □ 24564 068 50 x 50 cm



PATINE **Solid Yellow**
 □ 24564 067 50 x 50 cm

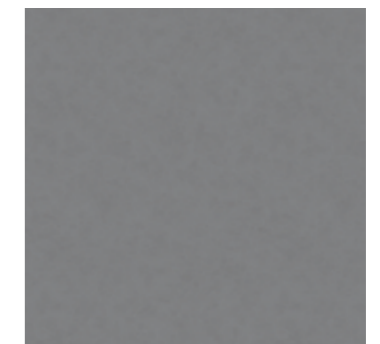

PATINE **Anthracite**
 □ 24564 044 50 x 50 cm



PATINE **Solid Blue**
 □ 24564 065 50 x 50 cm



PATINE **Solid Green**
 □ 24564 066 50 x 50 cm



PATINE **Grey**
 □ 24564 002 50 x 50 cm
 □ 24578 002 100 x 100 cm



PATINE
CHALK
24564 064

PATINE
SOLID BLUE
24564 065

PATINE
SOLID RED
24564 06



VINTAGE ZINC
OXYDE
24563 069

PATINE
SOLID GREEN
24564 066

PATINE
SOLID YELLOW
24564 067



ENGLISH OAK
WARM GOLD
24576 302

WOVEN VINYL
DARK
24562 090

MARBLE PULPIS
GOLDEN BLACK
24565 077

Caring
workspace

DASHES
CAMEL
24562 071

DASHES
GREEN
24562 070

ENGLISH OAK
BEIGE
24576 305

ENGLISH OAK
WARM GOLD
24576 302

CARING WORKSPACE

Today's forward-thinking companies, which advocate employee-centric culture, strive to foster workplace wellbeing and to encourage work-life balance. This trend is on the rise and it should continue its momentum. In an effort to achieve high levels of employee-wellbeing, healthy materials are used by workplace designers to create dynamic work environments for both focused work and restorative activities to make employees feel at home and comfortable.

Human-centered design and innovative furniture such as adjustable workstations or standing desks positively contribute to increased worker productivity and improved overall health.

Tarkett designers have combined different textures and used subtle variations in natural hues to add depth and passion to these spaces and support a Work better live better motto.



PATINE
□ 24564 040
Light Chocolate
50 x 50 cm



TISSE
□ 24560 033
Chocolate
50 x 50 cm



WOVEN VINYL
□ 24562 091
□ 24589 091
Natural
50 x 50 cm
100 x 100 cm



CHAMBRAY
□ 24563 084
Ochre
50 x 50 cm



WOVEN VINYL
□ 24562 092
Bicolor
50 x 50 cm



CHAMBRAY
□ 24563 083
Green
50 x 50 cm



PATINE
□ 24564 064
Chalk
50 x 50 cm



MINIMAL WOOD
▣ 24567 101
□ 24563 101
Grey
25 x 100 cm
50 x 50 cm



MINIMAL WOOD
▣ 24567 100
□ 24563 100
Natural
25 x 100 cm
50 x 50 cm



CITIZEN OAK
▣ 24593 088
▣ 24597 088 Chevron Left
▣ 24599 088 Chevron Right
Natural
20 x 120 cm



CITIZEN OAK
▣ 24593 087
▣ 24597 087 Chevron Left
▣ 24599 087 Chevron Right
Golden
20 x 120 cm



ENGLISH OAK
▣ 24576 305
Beige
25 x 100 cm



ENGLISH OAK
▣ 24576 301
Grege
25 x 100 cm



ENGLISH OAK
▣ 24576 304
Dark Grege
25 x 100 cm



ENGLISH OAK
GREGE
24576 301

CHAMBRAY
GREY BEIGE
24563 082



CITIZEN OAK
GOLDEN
24593 087

CHAMBRAY
GREEN
24563 083



CHAMBRAY
OCHRE
24563 084

WOVEN VINYL
NATURAL
24562 091

WOVEN VINYL
BICOLOR
24562 092



Hospitality

DASHES
CAMEL
24562 071

TRAVERTINE
CHALK
24563 076

CITIZEN OAK
GOLDEN
24597 087
24599 087

HOSPITALITY

The hospitality industry is ever-changing and with enhanced technology entering the market the global scene is changing faster than ever before. Players become more innovative to provide exceptional experiences hoping to go beyond their guests' high expectations.

Online and iPad check-ins are inducing the front reception areas mutation. Thus, more front desks will be replaced with sit-down digital concierge services and other public areas will shift from business-like spaces to warm and inviting areas. Hotels are also going big on the smart room concept to transform the hotel room experience. Undertaking these changes requires great agility including in the flooring installation process to minimize downtime and reduce costs.

Our designing team aspires to be a part of this story, by offering guests a more unpredictable and personalized experience which is why our designs offer soothing patterns, with cool and warm tones and enhanced with a touch of brass.



TRAVERTINE **Chalk**
 □ 24563 076 50 x 50 cm



MARBLE PULPIS **Golden Black**
 □ 24565 077 66 x 66 cm
 □ 24588 077 100 x 100 cm



ENGLISH OAK **Black**
 □ 24576 300 25 x 120 cm



ENGLISH OAK **Warm Gold**
 □ 24576 302 25 x 120 cm



CITIZEN OAK **Golden**
 □ 24593 087 20 x 120 cm
 □ 24597 087 Chevron Left
 □ 24599 087 Chevron Right



WALNUT **Walnut**
 □ 24593 089 20 x 120 cm

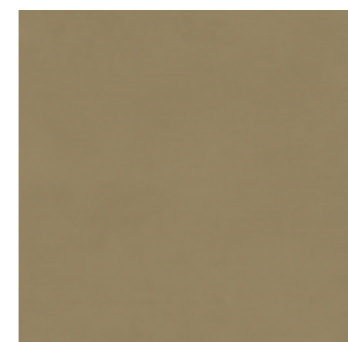

DASHES **Camel**
 □ 24562 071 50 x 50 cm



DASHES **Green**
 □ 24562 070 50 x 50 cm



DASHES **Petrol**
 □ 24562 072 50 x 50 cm



ENGLISH OAK
BLACK
24576 300

DASHES
CAMEL
24562 071

MARBLE PULPIS
GOLDEN BLACK
24588 078



TRAVERTINE
CHALK
24563 076

WALNUT
WALNUT
24593 089



ENGLISH OAK
WARM GOLD
24576 302

DASHES
PETROL
24562 072

Fusion: a beautiful balance of iD Square and carpet tiles

DESSO
DESERT AIRMASTER
8834

iD SQUARE VINTAGE ZINC
METALIC
24565 002

MIX WITH CARPET FOR CAPTIVATING INTERIORS

Creativity is at the heart of good design along with the desire to make a mark. With our Fusion concept, we combine iD Square with DESSO carpet tiles, to create stunning and practical flooring for contemporary spaces. We've designed the iD Square and DESSO carpet tile products in the Fusion collection to work together seamlessly, with no transition strips. For more inspiration and information please visit www.tarkettfusion.com

iD Square flooring and DESSO carpet tile products are simply the perfect fit. The designs and products of Tarkett Fusion have been carefully selected to not only match aesthetically, but also from a functional perspective. The slight difference in height between Fusion Desso Carpet tiles and iD Square (maximum 2,5mm*) allows for a seamless transition with no strips needed.

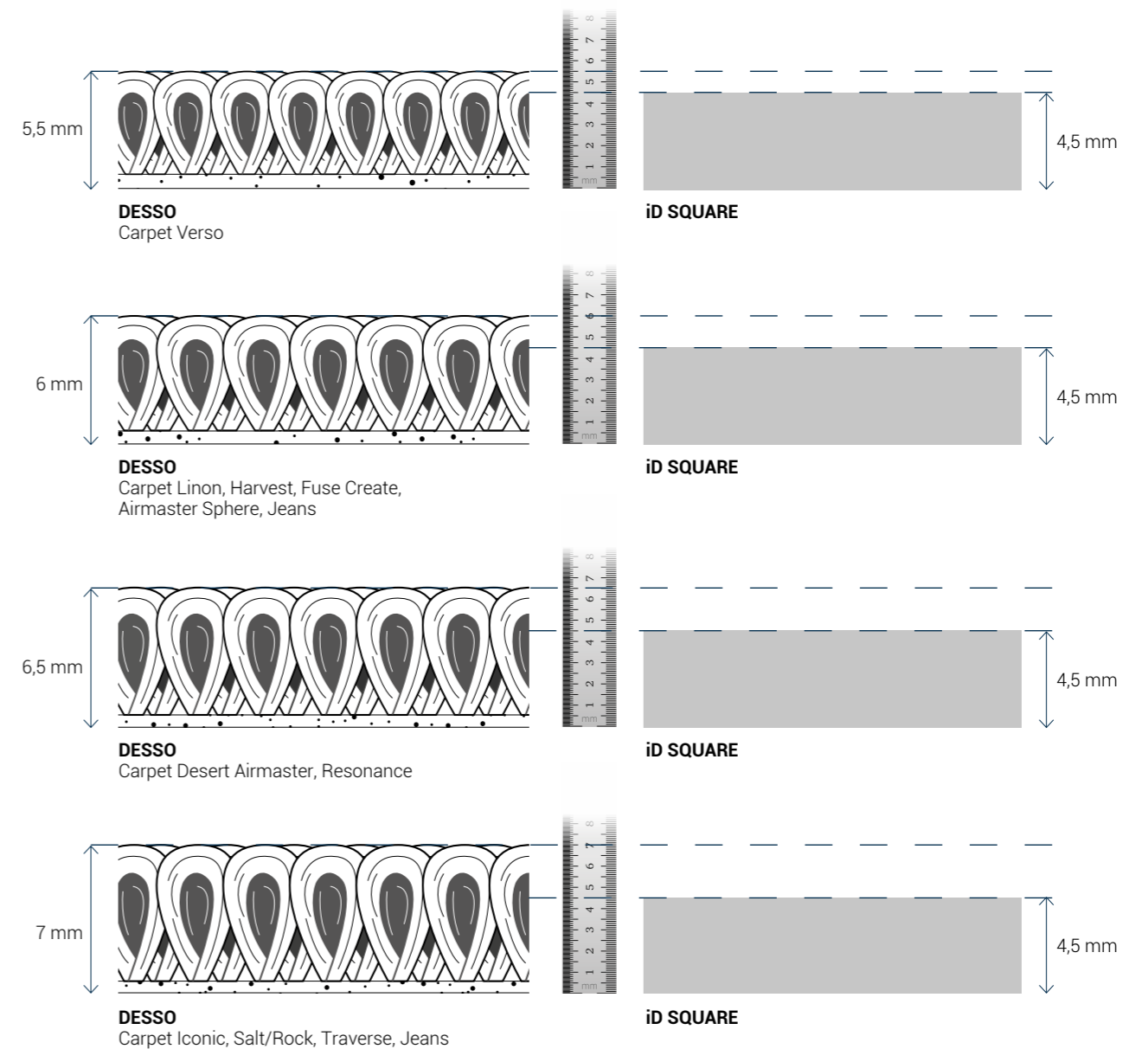

*We advise to keep a height difference of maximum 2.5 mm between Carpet tiles and LVT, to avoid strips or leveling.

MIX WITH CARPET

FLEXIBLE WORKSPACE



DESSO Resonance 8932 - iD SQUARE Patine Dark Anthracite 24564046

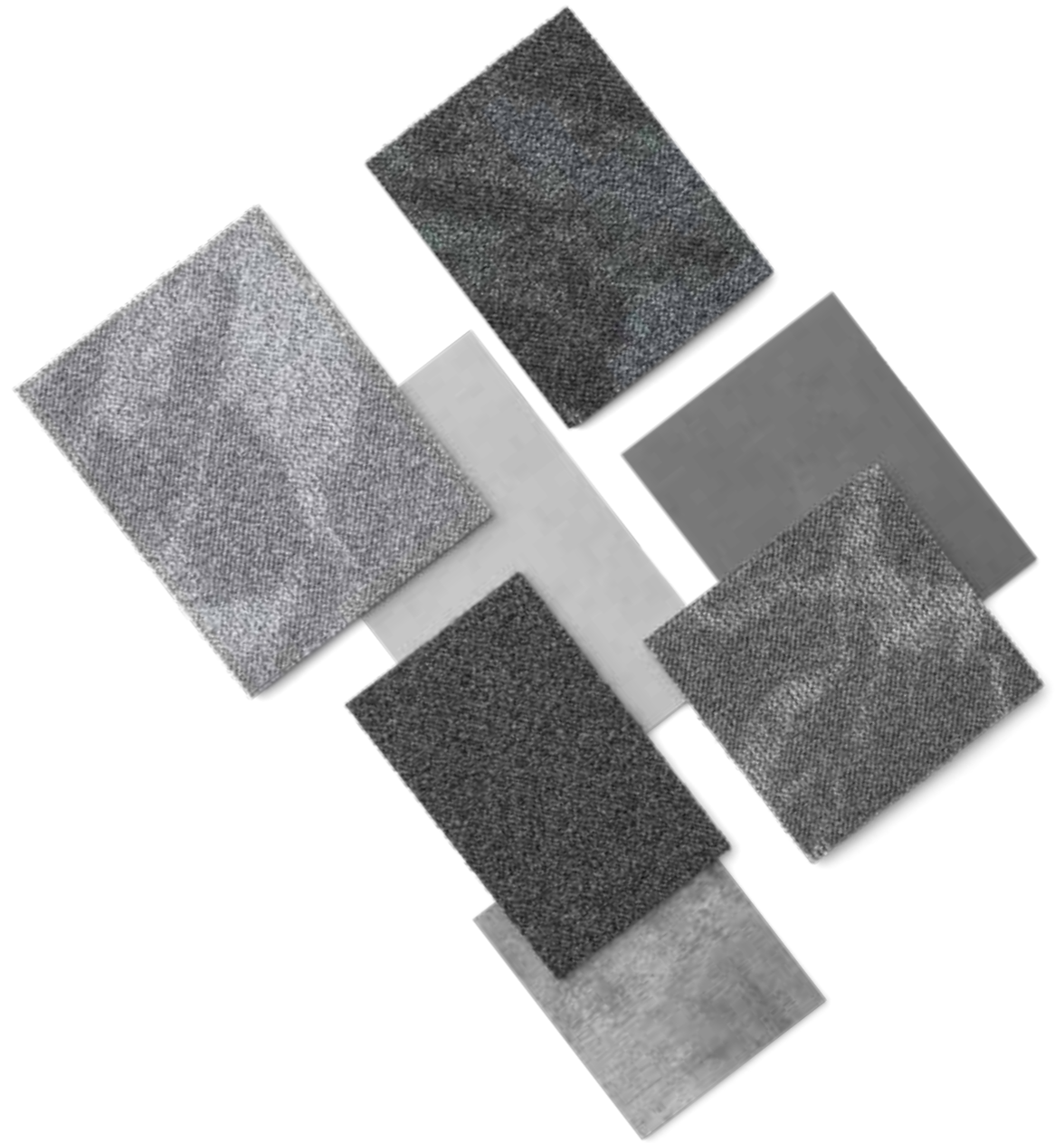

DESSO Resonance 1701, 8932, 9503 / Rock 9511 - iD SQUARE Patine Dark Anthracite 24564046 / Vintage Zinc Dark Grey 24565000 / Vintage Zinc Metallic 24564002

MIX WITH CARPET

COLLABORATIVE WORKSPACE



DESSO Harvest 2915 - iD SQUARE English OAK Beige 24576305



DESSO Desert AirMaster® 9970 / Fields 7231 / Linon 2015 / Iconic 2906 / Traverse 6214 - iD SQUARE English Oak Dark Grege 24576304 / English Oak Beige 24576305

MIX WITH CARPET

CARING WORKSPACE



DESSO Salt 7061/ Rock 7065 - **iD SQUARE** Patine Grey 24564002



DESSO Salt 7061 / Rock 7065 / Fields 9515 - **iD SQUARE** Patine Grey 24564002

MIX WITH CARPET

HOSPITALITY



DESSO Traverse 4437 - **ID SQUARE** English OAK Grege 24576301



DESSO Harvest 2915 / Iconic 9097 / Traverse 4437 / Traverse 4405 - **ID SQUARE** English Oak Warm Gold 24576302 / English Oak Grege 24576301



Doing Good. Together.

At Tarkett, we believe that together, we can make a positive impact on people and the planet. We strive to make high quality, sustainable flooring to help you create healthier and people-friendly spaces.

We listen to our customers' needs and collaborate with all our stakeholders to design products that deliver optimal performance, promote healthy living and respect natural resources.

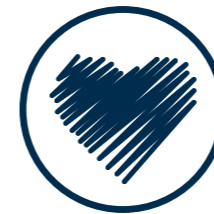

We are designing for life

We recycle waste from our production, transforming it into new, high quality products. In this way, we can contribute to safeguarding the world's natural resources and protecting the environment. iD Square is close to 100% phthalate-free and also showcases very low VOC emissions for optimal indoor air quality. This flooring is also reinforced with Topcean XP™, a UV photo crosslinked polyurethane which permanently suppresses any wax and regenerating operations and allows for easy maintenance (dry cleaning). Through our focus on Cradle to Cradle® design, we make our products in a way that helps to preserve natural resources and mitigate climate change.



We are closing the loop

We recycle waste from our production, transforming it into new, high quality products. In this way, we can contribute to safeguarding the world's natural resources and protecting the environment, and by closing the loop, shift to a circular economy.



We're driving collaboration

The world's great sustainability challenges require co-operation and partnership across industries and supply chains. We encourage our customers and all our stakeholders to join us in working toward positive change. Importantly, we communicate our sustainability progress transparently, and provide you with clear information about our products and ambitions.

Doing Good. Together.

Every day, we strive to improve people's lives,
preserve natural resources and respect our environment.

DESIGNED TO SAVE YOU TIME AND MONEY

Product construction

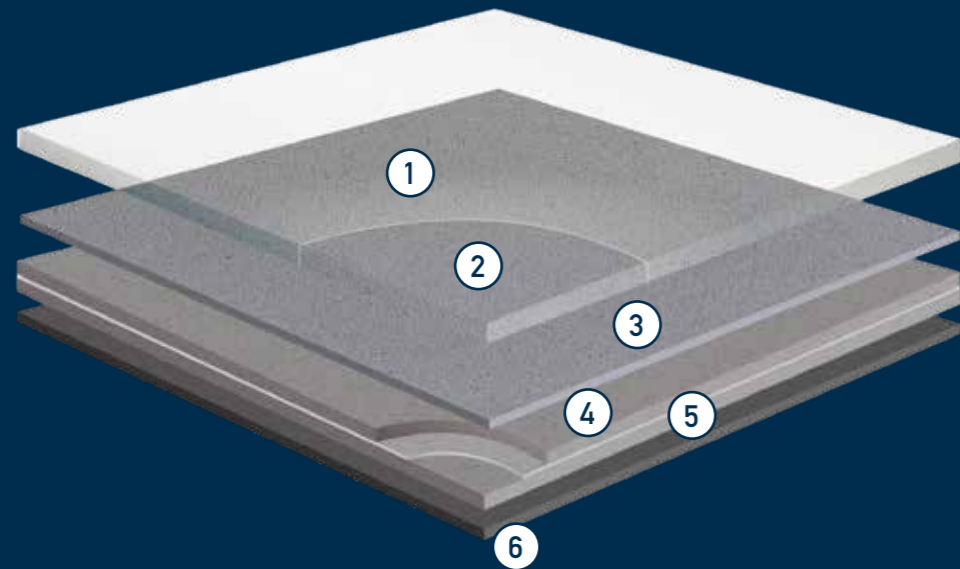

① TopClean XP™ PUR reinforcement
Wear layer reinforced with a UV photo cross-linked PUR treatment which permanently suppresses any wax and regenerating operations, allows for easy maintenance and extra resistance to scuffs, scratches and stains

② 0.80mm pure PVC transparent wear layer
A class leading wear layer for extreme resistance to wear

③ Decorated compact impregnation
50 design options

④ Acoustic layer built with solid homogeneous calandered layers reinforced with non-woven glass fibre
To help reduce impact noise pollution and ensure excellent resistance to tear and indentation

⑤ Non-woven glass fibre layer
For exceptional dimensional stability preventing the floor from expanding or contracting

⑥ Chemical foam backing
To prevent lateral movements of the flooring

BRINGING YOU THE ULTIMATE ACOUSTIC COMFORT



BETTER ACOUSTIC COMFORT

Office acoustics contribute to performance and wellbeing in the workplace. iD Square dampens noise level in rooms and reduces sound transmission between floors to 15 dB thus contributing to employees comfort and improving their effectiveness. iD Square is also ideal for commercial projects including hospitality.



50 DESIGNS AND 7 FORMATS

iD Square displays an extensive selection of trendy patterns specifically crafted by Tarkett design studio. The designs mimic a variety of textile, artistic, wood and mineral decors, giving the flooring an authentic look.

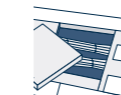

PRACTICALITY AT ITS BEST

Easy to install and just as easy to remove without damaging the substrate. You can have access effortlessly to the technical subfloor and benefit from a very simple maintenance over time. iD Square is very fast and easy to install with minimum floor preparation.



MODULARITY

All 50 designs and 7 formats can be mixed together to carry out elegant, creative projects and bring unexpected style to your floor. You can consult our layouts book on pages 40 & 49.

Also, iD Square can be combined with Desso Carpets, thanks to similar thicknesses and matching designs, to create the perfect fit and ensure seamless transitions. This provides you with an exceptionally diverse range and infinite combination possibilities.

Please see pages 60 for all possible format combinations.



HIGH QUALITY FOR HIGH TRAFFIC AREAS

Made in Europe and specifically developed for the demanding high traffic environments, iD Square is endowed with one of the thickest wear Layers on the market with 0,8mm. This results in an excellent dimensional stability that ensures a curl-free installation.



CUSTOMISATION

iD Square offers advanced possibilities of customization including the choice of colour, design and format . Please note that 1000 m² minimum order quantity is required for this category of service.



GREAT RESISTANCE

iD Square's hygienic surface treated with UV photo crosslinked polyurethane grants greater durability and allows for easy maintenance and extra resistance to scuffs, scratches, spread of water and stains. It permanently suppresses any wax and regenerating operations. Made in France, iD Square benefits from a 10 year commercial warranty.



ENVIRONMENTAL PERFORMANCE

Health is an important factor in optimizing performance at work. iD Square uses Phthalate-free technology and helps improve indoor air quality with VOC emissions below quantifiable levels, under 10µg/m³ after 28 days.

iD SQUARE COLLECTION

CARPET



Grey
24563 073 50 x 50 cm



Denim
24563 074 50 x 50 cm

CEMENT CHEVRON



Medium Grey
24567 096 25 x 100 cm

CEMENT



Light Grey
24563 094 50 x 50 cm



Medium Grey
24563 095 50 x 50 cm
24588 095 100 x 100 cm



Dark Grey
24563 093 50 x 50 cm

CHAMBRAY

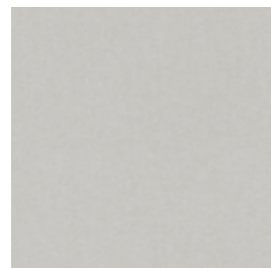

Grey Beige
24563 082 50 x 50 cm



Petrol
24563 086 50 x 50 cm



Denim
24563 079 50 x 50 cm



Dark Denim
24563 085 50 x 50 cm

CHAMBRAY



Ochre
24563 084 50 x 50 cm



Green
24563 083 50 x 50 cm

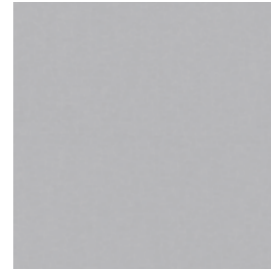

Light Grey
24563 080 50 x 50 cm
24588 080 100 x 100 cm

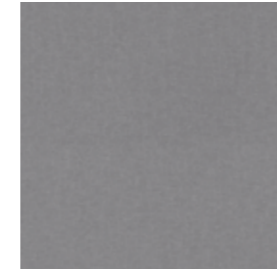

Dark Grey
24563 081 50 x 50 cm

DASHES

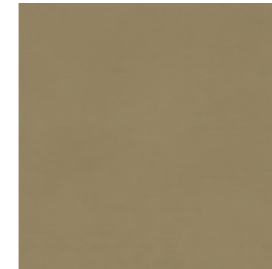

Camel
24562 071 50 x 50 cm

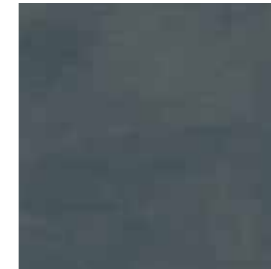

Petrol
24562 072 50 x 50 cm



Green
24562 070 50 x 50 cm

MARBLE PULPIS



Golden Black
24565 077 66 x 66 cm
24588 077 100 x 100 cm



Grey
24565 078 66 x 66 cm

PATINE

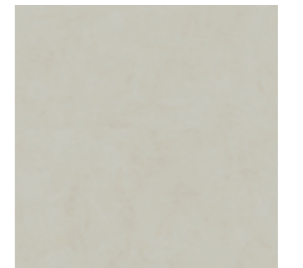

Chalk
24564 064 50 x 50 cm

PATINE



Light Chocolate
24564 040 50 x 50 cm



Grey
24564 002 50 x 50 cm
24578 002 100 x 100 cm



Anthracite
24564 044 50 x 50 cm

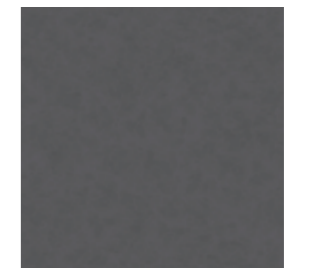

Dark Anthracite
24564 046 50 x 50 cm

PATINE



Solid Yellow
24564 067 50 x 50 cm



Solid Red
24564 068 50 x 50 cm



Solid Green
24564 066 50 x 50 cm



Solid Blue
24564 065 50 x 50 cm

iD SQUARE COLLECTION

TERRAZZO MURANO

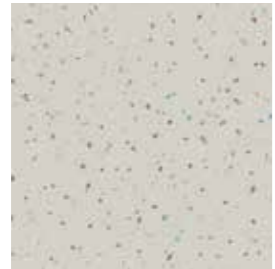

Multico
24563 075 50 x 50 cm

TRAVERTINE



Chalk
24563 076 50 x 50 cm

TISSE



Chocolate
24560 033 50 x 50 cm

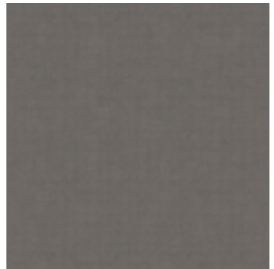

Dark Grey
24560 032 50 x 50 cm

VINTAGE ZINC



Metalic
24565 002 66 x 66 cm
24588 002 100 x 100 cm



Oxyde
24565 069 66 x 66 cm



Dark Grey
24565 000 66 x 66 cm

WOVEN VINYL



Bicolor
24562 092 50 x 50 cm



Natural
24562 091 50 x 50 cm
24589 091 100 x 100 cm



Dark
24562 090 50 x 50 cm

CITIZEN OAK



Golden
24593 087 20 x 120 cm
24597 087 Chevron Left 20 x 120 cm
24599 087 Chevron Right 20 x 120 cm



Natural
24593 088 20 x 120 cm
24597 088 Chevron Left 20 x 120 cm
24599 088 Chevron Right 20 x 120 cm

ENGLISH OAK



Beige
24576 305 25 x 100 cm



Grege
24576 301 25 x 100 cm



Dark Grege
4576 304 25 x 100 cm



Grey
24576 303 25 x 100 cm



Warm Gold
24576 302 25 x 100 cm



Black
24576 300 25 x 100 cm

MINIMAL WOOD



Natural
24567 100 25 x 100 cm
24563 100 50 x 50 cm



Grey
24567 101 25 x 100 cm
24563 101 50 x 50 cm



Dark Grey
24567 102 25 x 100 cm
24563 102 50 x 50 cm

WALNUT



Walnut
24593 089 20 x 120 cm

FORMATS & COMPATIBILITY

DESSO

.....



25 x 100 cm

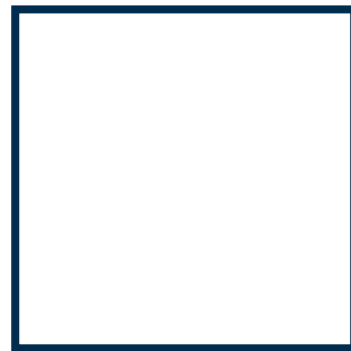

50 x 50 cm



100 x 100 cm

FORMATS & COMPATIBILITY

iD SQUARE

.....



25 x 100 cm



20 x 120 cm



20 x 120 cm
Chevron Right



20 x 120 cm
Chevron Left



50 x 50 cm



100 x 100 cm



66 x 66 cm

Bold shapes are compatible with DESSO carpet products.

ACCESSORIES

SKIRTING

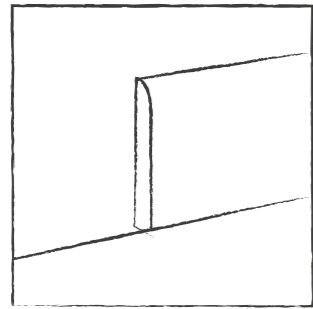

SKIRTING KS61 - 61 mm

- White - 1411002
- Black - 1411007
- Dark Grey - 1411008
- Medium Grey - 1411009
- Grey - 1411010
- Light Grey - 1411011
- Very Light Grey - 1411012
- Dark Brown - 1411013
- Red - 1411019
- Bright Orange - 1411047
- Beige - 1411021
- Medium Beige - 1411025
- Grege - 1411026
- Light Beige - 1411027
- Bright Yellow - 1411048
- Intense Plum - 1411049
- Rose Wood - 1411032
- Intense Olive - 1411050
- Blue Green - 1411035
- Green / Yellow - 1411036
- Dark Blue - 1411039
- Medium Blue - 1411041
- Sky Blue - 1411042
- Green Blue - 1411044
- Aluminium - 1411051
- Oak Long Strip Natural- 1411052
- Concrete Cool Grey - 1411053
- Dark Beige - 1411054
- Bright Turquoise - 1411055
- Intense Petrole - 1411056

WALL BASE DECORATIVE SET-ON SKIRTING iD SQUARE

Compact skirting with decorative film and PUR surface treatment, to be glued

SKIRTING KS80 - 80 mm

- White - 1411257
- Dark Grey - 1411258
- Medium Grey - 1411259
- Grey - 1411260
- Dark Beige - 1411261
- Concrete Cool Grey - 1411262

SKIRTING KS100 - 100 mm

- White - 1411163
- Dark Grey - 1411164
- Medium Grey - 1411165
- Grey - 1411166
- Dark Beige - 1411167
- Concrete Cool Grey - 1411168

PROFILE

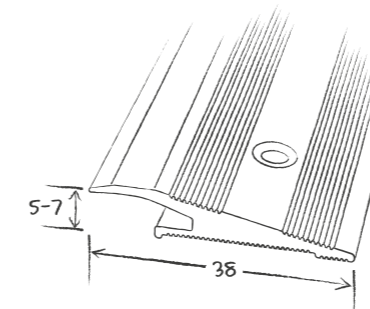
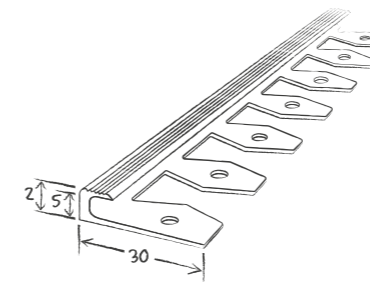
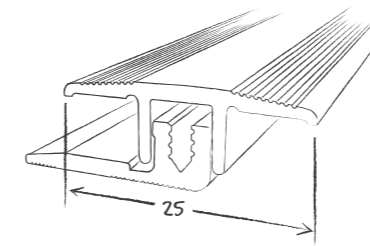

TRANSITION PROFILE

Very high traffic aluminium transition profile, to be screwed in

- Silver 1451 011
- Stainless Steel 1451 012
- 📦 10 units of 2.7 lm

BENDABLE PROFILE

Aluminium stop profile, to be screwed in

- Silver 1456 011
- Stainless Steel 1456 012
- 📦 10 units of 2.5 lm

RAMP PROFILE

Very heavy traffic aluminium profile, to be screwed in

- Silver 1454 011
- Stainless Steel 1454 012
- 📦 10 units of 2.7 lm

ACCESSIBILITY

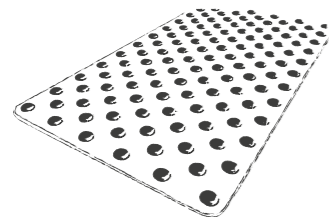
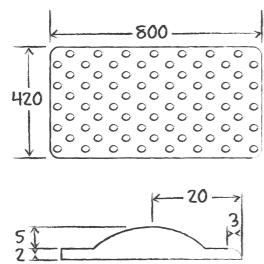
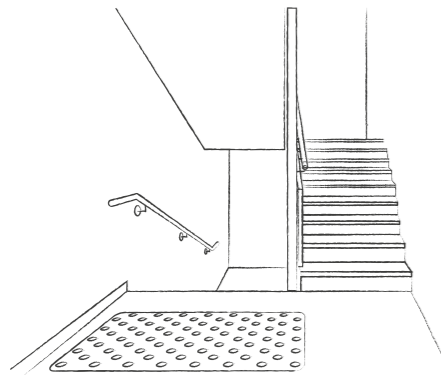

UNDERLAY

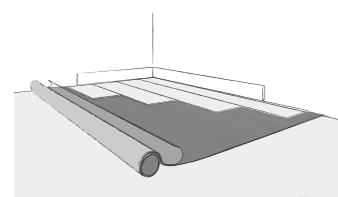

TARKOMFORT SELF-ADHESIVE

- High-class solution for reducing both impact sound and in-room noise
 - Quick and easy-to-install solution
 - Environmentally-friendly solution (90% natural raw materials)
- Black 24992 040

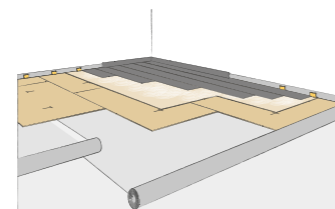

JUMPAX ORIGINAL®

- Levels existing subfloor perfectly via a ready-to-use, dual rigid-board floating system
 - Reduces noise by up to 21dB Lw
 - Provides greater resistance in heavy-traffic areas with its strong, rigid structure
- Beige 24993 010

WARNING TILE*

- Helps recognize a change in level, in accordance with regulatory requirements for disabled access and safety
- Self-adhesive or to be glued to the floorcovering (according to product), Format: 800 x 420 x 7mm

📦 1 box of 6 tiles

○ White 1431 001

● Black 1431 002

● Light Grey 1431 003

- Self-adhesive rectangular tiles, Format: 815 x 420 x 8mm

📦 1 box of 10 tiles

- Self-adhesive square tiles, Format: 450 x 420 x 8mm

📦 1 box of 10 tiles

○ White 1440 350 - 1440 450

● Grey 1440 351 - 1440 451

● Black 1440 352 - 1440 452

● Ivory 1440 353 - 1440 453

● Red 1440 354 - 1440 454

● Yellow 1440 355 - 1440 455

EASY KIT 3D STUDS

- Accessibility accessory
- Ready-to-use podotactile studs to be simply fitted on top of the existing floorcovering

● Grey 1440 551

● Black 1440 552

📦 5mm x 22.5mm for a 33 studs kit (8 kits per pack)

PRODUCT DETAILS

Design	Colour	Available formats in standard collection	References	NCS	LRV*
CARPET	Denim	50 x 50 cm	24563074	S5005-R80B	23.7%
	Grey	50 x 50 cm	24563073	S3502-R	41.5%
CEMENT	Dark grey	50 x 50 cm	24563093	S4502-Y	25.8%
	Light grey	50 x 50 cm	24563094	S2002-Y50R	49.4%
	Medium grey	50 x 50 cm	24563095	S3502-Y	35.0%
		100 x 100 cm	24588095		
CEMENT CHEVRON	Medium grey	25 x 100 cm	24567096	S3502-Y / S4502-Y	35.0%
	Dark denim	50 x 50 cm	24563085	S6010-R70B	15.9%
CHAMBRAY	Dark grey	50 x 50 cm	24563081	S5502-R	20.8%
	Denim	50 x 50 cm	24563079	S4010-R70B	29.5%
	Green	50 x 50 cm	24563083	S3020-G70Y	35.3%
	Grey beige	50 x 50 cm	24563082	S3005-Y80R	43.9%
	Light grey	50 x 50 cm	24563080	S3502-R	37.1%
		100x100 cm	24563080		
	Ochre	50 x 50 cm	24563084	S4050-Y50R	26.9%
Petrol	50 x 50 cm	24563086	S6010-B30G	15.4%	
CITIZEN OAK	Golden	20 x 120 cm	24593087	S4020-Y30R	31.3%
		20 x 120 cm Chevron Left	24597087		
	Natural	20 x 120 cm Chevron Right	24599087	S4010-Y10R	30.8%
		20 x 120 cm	24593088		
DASHES	Camel	50 x 50 cm	24562071	S5010-Y30R	20.0%
	Green	50 x 50 cm	24562070	S6005-G20Y	15.7%
	Petrol	50 x 50 cm	24562072	S7005-B20G	9.1%
	Beige	25 x 100 cm	24576305	S4010-Y30R	32.1%
ENGLISH OAK	Black	25 x 100 cm	24576300	S7500-N	8.3%
	Dark grege	25 x 100 cm	24576304	S6005-Y20R	13.7%
	Grege	25 x 100 cm	24576301	S5005-Y50R	19.8%
	Grey	25 x 100 cm	24576303	S4500-N	26.7%
	Warm gold	25 x 100 cm	24576302	S5010-Y30R	19.9%
MARBLE PULPIS	Golden black	66 x 66 cm	24565077	S7005-R80B	13.0%
	Grey	100 x 100 cm	24588077	S4502-R	28.2%
MINIMAL WOOD	Dark grey	25 x 100 cm	24567102	S5005-Y80R	15.5%
	Grey	50 x 50 cm	24563102	S4010-Y30R	22.8%
		25 x 100 cm	24567101		
	Natural	50 x 50 cm	24567100	S5010-Y30R	20.8%
PATINE	Anthracite	50 x 50 cm	24564044	S6000-N	16.8%
	Chalk	50 x 50 cm	24564064	S2502-Y	48.6%
	Dark anthracite	50 x 50 cm	24564046	S7502-B	9.4%
	Grey	50 x 50 cm	24564002	S4500-N	26.1%
		100 x 100 cm	24578002		
	Light chocolate	50 x 50 cm	24564040	S4005-Y50R	29.9%
	Solid blue	50 x 50 cm	24564065	S4040-R90B	10.7%
	Solid green	50 x 50 cm	24564066	S4040-B90G	16.6%
Solid red	50 x 50 cm	24564068	S2060-Y90R	14.9%	
Solid yellow	50 x 50 cm	24564067	S2050-Y	44.8%	
TERRAZZO MURANO	Multico	50 x 50 cm	24563075	S2002-Y50R	58.0%
TISSE	Chocolate	50 x 50 cm	24560033	S5005-Y50R	19.7%
	Dark grey	50 x 50 cm	24560032	S6500-N	14.4%
TRAVERTINE	Chalk	50 x 50 cm	24563076	S1502-Y50R	62.8%
	Dark grey	66 x 66 cm	24565000	S5500-N	19.1%
VINTAGE ZINC	Metalic	66 x 66 cm	24565002	S4502-Y	29.8%
		100 x 100 cm	24588002		
Oxyde	66 x 66 cm	24565069	S6502-R	13.1%	
WALNUT	Walnut	20 x 120 cm	24593089	S6010-Y50R	17.9%
	Bicolor	50 x 50 cm	24562092	S7005-Y80R	11.9%
WOVEN VINYL	Dark	50 x 50 cm	24562090	S7502-Y	10.4%
	Natural	50 x 50 cm	24562091	S5005-Y20R	23.3%

CUSTOMIZATION RULES

Standard option

No min. quantity

Format change

Made to order
Min. 800 m²

Exclusive colour

Made to order
Min. 1000 m²

Tiles

50 x 50 cm

66 x 66 cm

100 x 100 cm

Planks

25 x 100 cm

20 x 100 cm

20 x 100 cm Chevron Left

20 x 100 cm Chevron Right

*Caution: the area around the warning tiles will be merged together

*LRV: Luminous Reflectance Value

TENDER SPECIFICATIONS

The selected flooring similar to iD Square belongs to EN ISO 10582 / EN 651 Acoustic resilient floor covering manufactured. It is a class 34, heavy commercial traffic, modular resilient with a PVC Wear Layer of 0,8mm.

It is available in several formats and shapes: Tiles of 50 x 50 cm / 66 x 66 cm / 100 x100 cm; Planks of 25 x 100 cm / 20 x 120 cm; Chevron of 20 x 120 cm 20 x 120 cm.

The wear layer of is reinforced with a UV photo crosslinked polyurethane including particles of alumina TopClean XP™ treatment, which permanently suppresses any wax and regenerating polish spray maintenance operations. It has a static indentation resistance ≤ 0,10mm.

Its emission rate of volatile organic compounds in air is less than 10 µg / m³ (TVOC after 28 days). It is 100% phthalate-free.

iD Square comes with a 10-Year Warranty.

TECHNICAL DATA SHEET

Classification	Standards	iD Square	
Classification	EN ISO 10582 / EN 651	Heterogeneous Acoustic Resilient Floorcovering	
	EN ISO 10874	Commercial: 34	
Wear layer binder content	EN ISO 10582	Type I	
Technical characteristics			
Total thickness	EN ISO 24346	4,5 mm	
Wear layer thickness	EN ISO 24340	0,80 mm	
Total weight	EN ISO 23997	5195 g/m²	
Bevelled edges	-	No	
Surface treatment (PUR)	-	Yes - TopCleanXP™	
Form of delivery	EN ISO 24342		
	Planks	25 x 100 cm 20 x 120 cm 20 x 120 cm Left chevron 20 x 120 cm Right chevron	9 planks/box = 2.25 m² 10 planks/box = 2,40m² 10 planks/box = 2,40m² 10 planks/box = 2,40m²
	Tiles	50 x 50 cm 66 x 66 cm 100 x100 cm	9 tiles/box = 2.25 m² 5 tiles/box = 2.22 m² 50 tiles/pallet = 50 m²

Performance for CE marking requirement (EN 14041)

Declaration Of Performance	EN 14041	0120-0067-DoP-2014-11
Reaction to fire	EN 13501-1	B _{fl} s1 loose-laid on an A1 _{fl} and/or A2 _{fl} substrate C _{fl} s1 loose-laid on a wooden sub-floor
Electrostatic properties	EN 1815 EN 1081	<2 kV on concrete > 10 ⁹ Ohm
Thermal resistance	EN ISO 10456	0,05 m² K/W
Antislip classification	EN 13893	µ ≥ 0.30

Technical performances

Dimensional stability	EN ISO 23999	≤ 0,10 %
Impact sound reduction	EN ISO 717-2	ΔL _w = 15 dB
Reduction of in-room impact noise	EN ISO 31-074	Class B - L _{n,R,W} = < 75 dB
Accoustical absorption	EN ISO 11654	∞ W = 0.05
Slip resistance	DIN 51130	R10/R11 depending on Embossing
Furniture leg	EN 424	No damage
Castor chair	ISO 4918	No damage
Light fastness	EN ISO 105-B02	≥ 6
Residual indentation	EN ISO 24343-1	≤ 0,10 mm
Chemical resistance	EN ISO 26987	Very good
Underfloor heating	-	Suitable - max. 27 °C

Environmental performances

Total VOC emission	ISO 16000-9	<10 µg/m³ (after 28 days)
Recyclable	-	100%
Plasticizer	-	Phthalate-free

The above information is subject to modification for the benefit of further improvement. (12/18).
Tarkett's instructions regarding installation, cleaning and maintenance should be observed.
Please contact Tarkett at the address shown for these instructions.

CUSTOMS TARIFF : 4820 5000 00

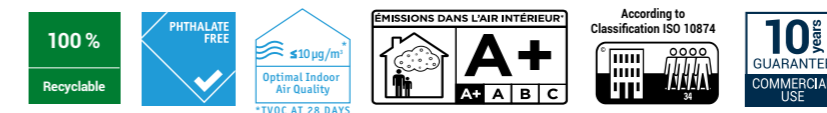



■ **WESTERN EUROPE:** Austria: Tarkett Holding GmbH, Niederlassung Wien - Tel. +43 1 47 88 062 ■ Belgium: Tarkett Belux N.V. - Tel. +32 52 26 24 11 ■ Denmark: Tarkett A/S - Tel. +45 43 90 60 11 ■ Finland: Tarkett Oy - Tel. +358 9 4257 9000 ■ France: Tarkett SAS - Tel. +33 1 41 20 42 49 ■ Germany: Tarkett Holding GmbH - Tel. +49 62 33 810 ■ Greece: Tarkett Monoprosopi Ltd - Tel. +30 210 6745 340 ■ Italy: Tarkett S.p.A. - Tel. +39 0744 7551 ■ Luxembourg: Tarkett Belux N.V. - Tel. +32 52 26 24 11 ■ Netherlands: Tarkett BV - Tel. +31 416 685 491 ■ Norway: Tarkett AS - Tel. +47 32 20 92 00 ■ Portugal: Tarkett SA - Tel. +351 21 427 64 20 ■ Spain: Tarkett Floors S.L. - Tel. +34 91 358 00 35 ■ Sweden: Tarkett Sverige AB - Tel. +46 771 25 19 00 ■ Switzerland: Tarkett Holding GmbH - Tel. +41 043 233 79 24 ■ Turkey: Tarkett Aspen - Tel. +90 212 213 65 80 ■ United Kingdom: Tarkett Ltd - Tel. +44 (0) 1622 854 040 ■ **EASTERN EUROPE:** Baltic Countries: Tarkett Baltics - Tel. +370 37 262 220 ■ Czech Republic: Tarkett org. slozka - Tel. +420 271 001 600 ■ Hungary: Tarkett Polska SP Z.O.O. magyarországi fióktelepe - Tel. +36 1 437 8150 ■ Poland: Tarkett Polska Sp. z o. o. - Tel. +48 22 16 09 231 ■ Russian Federation: ZAO Tarkett RUS - Tel. +7 495 775 3737 ■ Slovakia: Tarkett Polska, organizačná zložka - Tel. +421 2 48291 317 ■ South East Europe: Tarkett SEE - Tel. +381 21 7557 649 (44) 569 12 21 ■ Ukraine: Tarkett UA - Tel. +38 (0) 44 569 12 21 ■ **ASIA AND OCEANIA:** Australia: Tarkett Australia Pty Ltd - Tel. +61 2 88 53 12 00 ■ China: Tarkett Floor Covering (Shanghai) Co. Ltd. - Tel. +86 (21) 60 95 68 38 ext 841 ■ North East Asia: Tarkett Hong Kong Limited - Tel. +852 2511 8716 ■ India: Tarkett Flooring India Pvt. Ltd. - Bangalore - Tel. +91 80 4130 3793 - New Delhi - Tel. +91 11 4352 4079 - Mumbai - Tel. +91 22 2648 8750 ■ South East Asia: Tarkett Flooring Singapore Pte. Ltd. - Tel. +65 6346 1585 ■ **AFRICA:** Tarkett International: Tel. +33 1 41 20 41 01 ■ **MIDDLE EAST:** Tarkett Middle East: Tel. +961 1 51 3363/4 ■ Israel: Tarkett International: Tel. +33 1 41 20 41 01 ■ **NORTH AMERICA:** USA: Tarkett Inc. - Tel. +1 713 869 5811 / Johnsonite - Tel. +1 440 543 8916 ■ Canada: Tarkett Inc. - Tel. +1 450 293 173 ■ **LATIN AMERICA:** Brazil: Tarkett - Tel. 55 12 3954 7108 ■ Argentina - Chile - Uruguay: Tarkett Latam Mercosur - Tel. +54 11 47 08 07 72 / +549 11 44 46 88 82 ■ Bolivia - Colombia - Ecuador - Panama - Paraguay - Peru - Trinidad and Tobago - Venezuela: Tarkett - Tel. +55 11 9 841 09310 / +55 11 95494 0069 ■ Mexico / Central America: Tarkett Latam Mexico - Tel. +55 11 98410 9310

The designs and photos used in this brochure are for illustration purposes only. They are not contractual images and do not stand for product recommendation. Design: AgenceGecko / Photos: Getty images - Studio des plantes / Print: Lamazière

www.professionals.tarkett.com



 **Tarkett**